











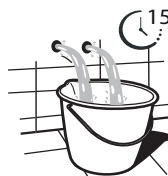

# CB033

3-hole washbasin mixer  
Batteria 3 fori da lavabo  
Mélangeur 3 trous de lavabo  
3-Loch-Waschtischbatterie  
Mezclador de lavabo de 3 agujeros  
Opbouw wastafelmengkraan 3 gats

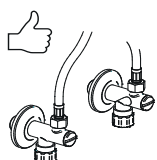
hotbath  
italian bathroomware

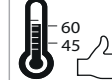

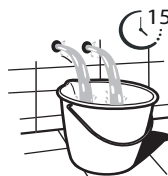
## BEFORE STARTING / PRIMA DI INIZIARE / AVANT DE COMMENCER / ANTES DE EMPEZAR / VOR DEM START / VOORDAT JE BEGINT

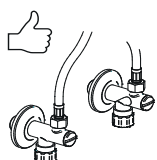
 <b>P</b> bar	 MAX 5 1 MIN	 3 thumbs up	 ON OFF	 15s	 OFF	 thumbs up FILTER TAPS RECOMMENDED
 T °C	 MAX 80	 60 45 thumbs up	 ON OFF	 15s	 OFF	 thumbs up FILTER TAPS RECOMMENDED

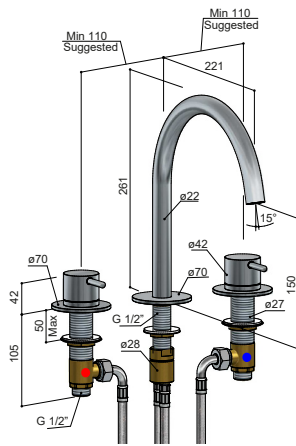

INSTALLATION

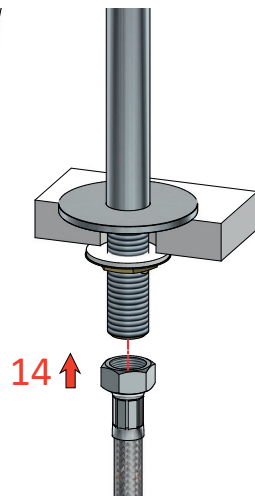
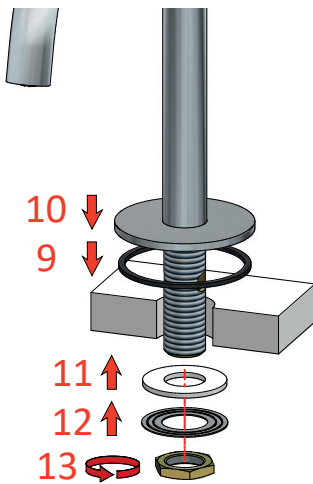
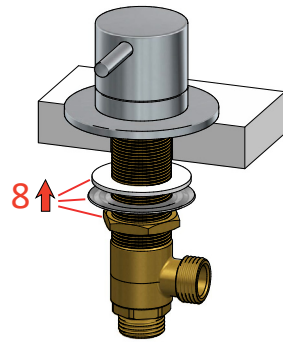
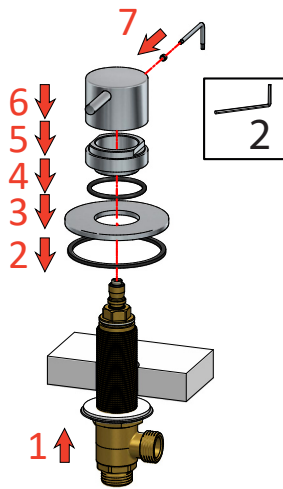

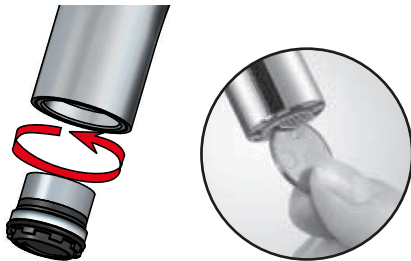
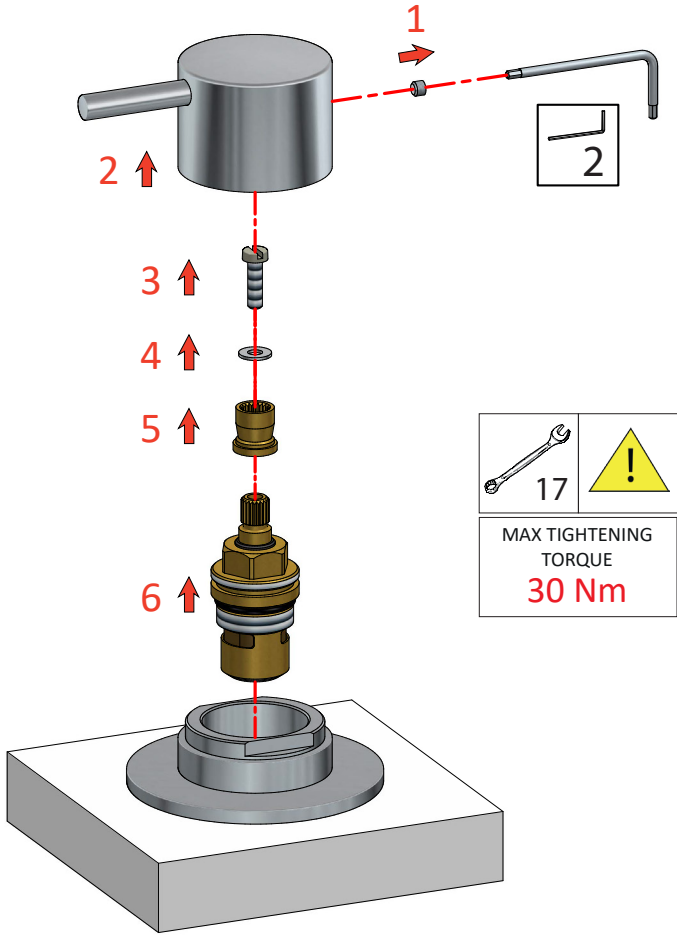

CLEANING - PULIZIA - NETTOYAGE - REINIGUNG - LIMPIEZA - REINIGING

			WARNING											
<b>CR</b> CHROME	<b>GN</b> BRUSHED NICKEL	Inoxidable electrolitic finish Finitura elettrolitica inossidabile Finition électrolytique inoxydable Inoxidierbare elektrolytische Ausführung Acabado electrolítico inoxidable Inoxidable elektrolitische afwerking							<input checked="" type="checkbox"/>	<input checked="" type="checkbox"/>	<input checked="" type="checkbox"/>	<input checked="" type="checkbox"/>	<input checked="" type="checkbox"/>	<input checked="" type="checkbox"/>
<b>BB</b> BRUSHED BRASS	<b>BC</b> BRUSHED COPPER	<b>NB</b> NATURAL BRASS	Natural metal finish: patina will form over time Finitura di metallo naturale: si formerà una patina nel tempo Finition en métal naturel: une patine se formera avec le temps Natürliche Metallausführung: eine Patina wird sich mit der Zeit bilden Acabado metálico natural: la patina se formará con el tiempo Natuurlijke metalen afwerking: na verloop van tijd vormt zich patina						<input checked="" type="checkbox"/>	<input checked="" type="checkbox"/>	<input checked="" type="checkbox"/>	<input checked="" type="checkbox"/>	<input checked="" type="checkbox"/>	<input checked="" type="checkbox"/>
	<b>AB</b> AGED BRASS	Aged metal finish: patina will form over time Finitura di metallo invecchiato: si formerà una patina nel tempo Finition en métal vieilli: une patine se formera avec le temps Gealterte Metallausführung: eine Patina wird sich mit der Zeit bilden Acabado de metal envejecido: la patina se formará con el tiempo Verouderde metalen afwerking: na verloop van tijd vormt zich patina							<input checked="" type="checkbox"/>	<input checked="" type="checkbox"/>	<input checked="" type="checkbox"/>	<input checked="" type="checkbox"/>	<input checked="" type="checkbox"/>	<input checked="" type="checkbox"/>
<b>BL</b> MATT BLACK	<b>WH</b> MATT WHITE	Varnished finish: subject to scratches if not properly handled Finitura verniciata: soggetta a deterioramento se non trattata correttamente Finition vernie: sujette aux rayures si ne pas traitée correctement Lackierte Ausführung: Kratzer bei unsachgemäßer Behandlung Gelakte afwerking: gevoelig voor krassen als er niet goed mee wordt omgegaan							<input checked="" type="checkbox"/>	<input checked="" type="checkbox"/>	<input checked="" type="checkbox"/>	<input checked="" type="checkbox"/>	<input checked="" type="checkbox"/>	<input checked="" type="checkbox"/>
<b>BK</b> BLACK CHROME	<b>AI</b> AGED IRON	Plated finish: subject to scratches if not properly handled Finitura placcata: soggetta a deterioramento se non trattata correttamente Finition plaquée: sujette aux rayures si ne pas traitée correctement Plattierte Ausführung: Kratzer bei unsachgemäßer Behandlung Geplaatde afwerking: gevoelig voor krassen als er niet goed mee wordt omgegaan							<input checked="" type="checkbox"/>	<input checked="" type="checkbox"/>	<input checked="" type="checkbox"/>	<input checked="" type="checkbox"/>	<input checked="" type="checkbox"/>	<input checked="" type="checkbox"/>
<b>BBP</b> BRUSHED BRASS PVD	<b>BCP</b> BRUSHED COPPER PVD	<b>NBP</b> NATURAL BRASS PVD	Inoxidable PVD finish Finitura PVD inossidabile Finition PVD inoxydable Inoxidierbare PVD Ausführung Acabado PVD inoxidable Inoxidable PVD afwerking						<input checked="" type="checkbox"/>	<input checked="" type="checkbox"/>	<input checked="" type="checkbox"/>	<input checked="" type="checkbox"/>	<input checked="" type="checkbox"/>	<input checked="" type="checkbox"/>

TERMS OF SALE AND WARRANTY  
CONDIZIONI DI VENDITA E GARANZIA  
CONDITIONS DE VENTE ET GARANTIE

CONDICIONES DE VENTA Y GARANTÍA  
VERKAUFSBEDINGUNGEN UND GARANTIE  
VERKOOP- EN GARANTIEVOORWAARDEN

NETHERLANDS  
BELGIUM  
LUXEMBOURG  
UK AND IRELAND

ALL COUNTRIES  
(EXCEPTED BENELUX, UK AND IRELAND)

<https://www.hotbath.nl/garantie>

<https://hotbath.it/en/termsforsale>



Hotbath B.V.  
Nieuwland Parc 210  
2952 DC Alblasserdam  
Nederland  
E [info@hotbath.nl](mailto:info@hotbath.nl)  
W [hotbath.nl](http://hotbath.nl)



Hotbath Srl  
Via Marco Polo 135/D  
I-55049 Viareggio  
Italy  
E [info@hotbath.it](mailto:info@hotbath.it)  
W [hotbath.it](http://hotbath.it)

hotbath  
italian bathroomware