

2	RARV135-2EXT-00	External parts for RARV135-2	1
1	MBASES3-00	Concealed parts for RARH50-2, RARV135-2	1
ID Nr	Code	Description	Pcs

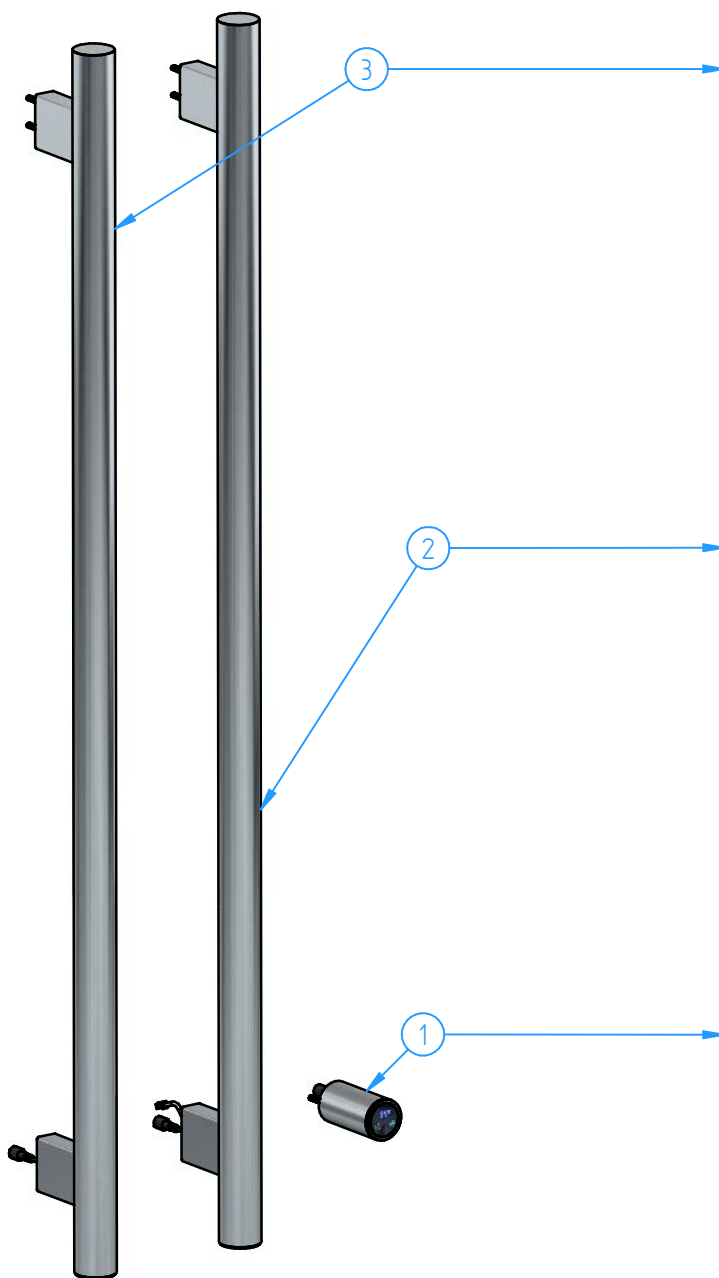

3	RARV135-00	Rail (without thermometer)	1
2	RARV135T-00	Rail (with thermometer)	1
1	SWIROU-00	Thermocontrol set	1
ID Nr	Code	Description	Pcs

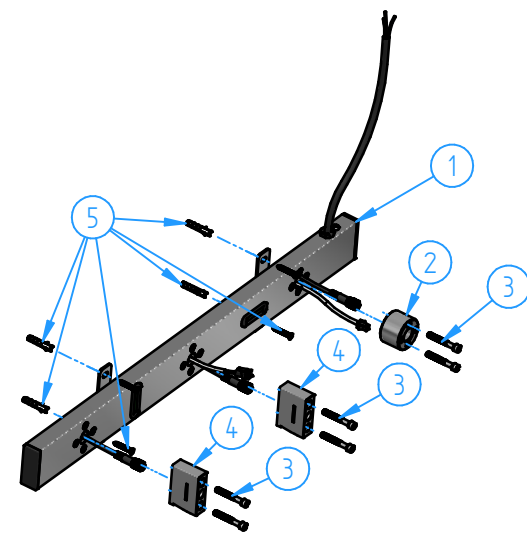

5	MBASES2-002	Fixing kit	1
4	MBASES-04	Support body for thermoelement	2
3	MBASES-05	Screw M5x35	6
2	MBASES-01	Control support body	1
1	MBASES3-001	Concealed preassembled set	1
ID Nr	Code	Description	Pcs

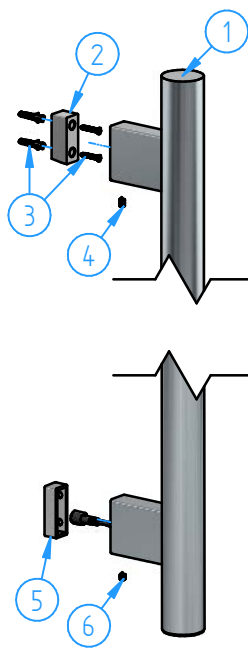

6	RARV135-07	Dowel M5x8	1
5	RARV135-05	Centering insert	1
4	RARV135-08	Dowel M5x10	1
3	RARV135-002	Fixing kit	1
2	RARV135-06	Bracket for wall fixing	1
1	RARV135-001	Rail set body (without thermometer)	1
ID Nr	Code	Description	Pcs

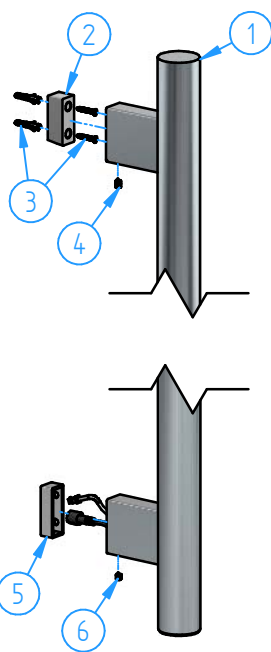

6	RARV135-07	Dowel M5x8	1
5	RARV135-05	Centering insert	1
4	RARV135-08	Dowel M5x10	1
3	RARV135-002	Fixing kit	1
2	RARV135-06	Bracket for wall fixing	1
1	RARV135T-001	Rail set body (wth thermometer)	1
ID Nr	Code	Description	Pcs

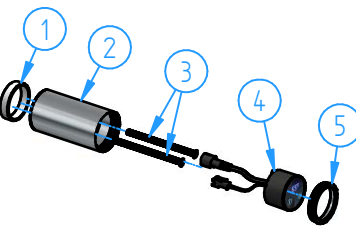

5	SWIROU-02	Cover	1
4	SWIRAR-001	Thermorgulation button	1
3	SWIRAR-05	Screw M5x88	2
2	SWIROU-01	Thermocontrol body	1
1	SWIROU-03	Centering ring	1
ID Nr	Code	Description	Pcs

N°		REVIEW	Date	Sheet	1 of 3
Description		Vertical radiator with 2 rail		Scale	1:8
Code		Date of issue	Chamfers not quoted	Material	
RARV135-2-00		10/06/2026	0.5x45°	Weight	0 kg
<small>This drawing is property reserved of Hotbath Srl. Without express authorization, the copying, distribution and utilization of this document as well as the communication to others is prohibited.</small>					